

Ezi-SERVO[®]

Closed Loop Stepping System

- Motor + Encoder + Drive + Controller + Network
- Embedded Controller
- Position Table
- Closed Loop System
- No Gain Tuning / No Hunting
- High Resolution / Fast Response
- IP65 Protection (NEMA24 Size)

ALL



CE

FASTECH

Fast, Accurate, Smooth Motion



Fast, Accurate, Smooth Motion

Ezi-SERVO[®] ALL

Closed Loop Stepping System



2 Position Table Function

Position Table can be used for motion control by digital input and output signals of host controller. You can operate the motor directly by sending the position table number, start/stop, origin search and other digital input values from a PLC.

The PLC can monitor the In-Position, origin search, moving/stop, servo ready and other digital output signals from a drive. A maximum of 64 positioning points can be set from PLC.



3 Closed Loop System

Ezi-SERVO® is an innovative closed loop stepping motor and controller that utilizes a high-resolution motor mounted encoder to constantly monitor the motor shaft position. The encoder feedback feature allows the Ezi-SERVO® to update the current motor shaft position information every 25 micro seconds. This allows the Ezi-SERVO® drive to compensate for the loss of position, ensuring accurate positioning. For example, due to a sudden load change, a conventional stepper motor and drive could lose a step creating a positioning error and a great deal of cost to the end user!

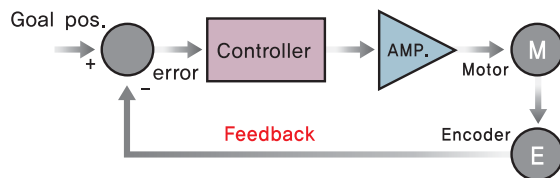

1 Network Based Motion Control

A maximum of 16 axis can be operated from a PC through RS-485 communications. All of the Motion conditions are set through the network and saved in Flash ROM as a parameter. Motion Library(DLL) is provided for programming under Windows 2000/XP.

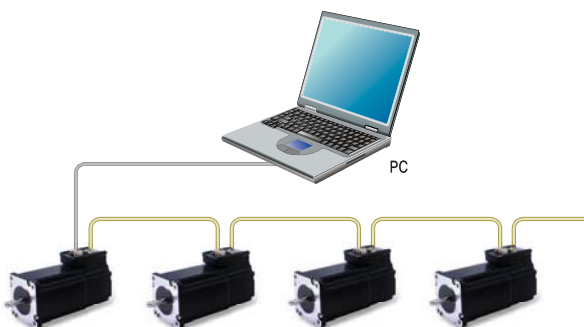

4 Absolute Encoder System

High resolution of absolute position encoder is equipped (single turn-262,144/rev, multi turn-4096 rev) In addition, even power supply of driver shuts off, it enables to know the previous location and the secondary power supply for the encoder (ie : battery) is not required.

*Only for Ezi-SERVO-ALL-60L-ABS



5 IP65 Certification

By acquiring IP65 rating, it can be used in harsh environments like water splashes or lots of dusts.

*Only for Ezi-SERVO-ALL-60mm

6 No Gain Tuning

Conventional servo systems, to ensure machine performance, smoothness, positional error and low servo noise, require the adjustment of its servo's gains as an initial crucial step. Even systems that employ auto-tuning require manual tweaking after the system is installed, especially if more than one axis are interdependent. Ezi-SERVO[®] employs the best characteristics of stepper and closed loop motion controls and algorithms to eliminate the need of tedious gain tuning required for conventional closed loop servo systems. This means that Ezi-SERVO[®] is optimized for the application and ready to work right out of the box! The Ezi-SERVO[®] system employs the unique characteristics of the closed loop stepping motor control, eliminating these cumbersome steps and giving the engineer a high performance servo system without wasting setup time. Ezi-SERVO[®] is especially well suited for low stiffness loads (for example, a belt and pulley system) that some-time require conventional servo systems to inertia match with the added expense and bulk of a gearbox. Ezi-SERVO[®] also performs exceptionally, even under heavy loads and high speeds!

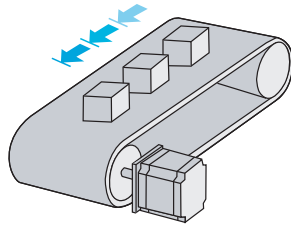

7 No Hunting

Traditional servo motor drives overshoot their position and try to correct by overshooting the opposite direction, especially in high gain applications. This is called null hunt and is especially prevalent in systems that the break away or static friction is significantly higher than the running friction. The cure is lowering the gain, which affects accuracy or using Ezi-SERVO[®] Motion Control System! Ezi-SERVO[®] utilizes the unique characteristics of stepping motors and locks itself into the desired target position, eliminating Null Hunt. This feature is especially useful in applications such as nanotech manufacturing, semiconductor fabrication, vision systems and ink jet printing in which system oscillation and vibration could be a problem.

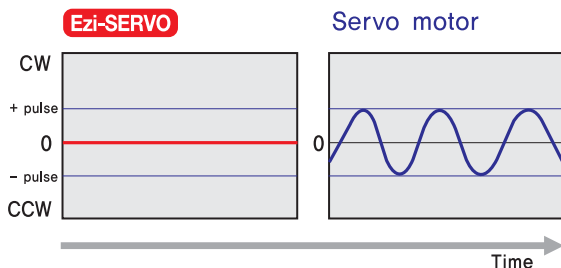
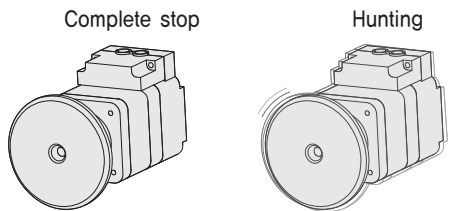

8 Smooth and Accurate

Ezi-SERVO[®] is a high-precision servo drive, using a high-resolution encoder with 32,000 pulses/revolution. Unlike a conventional Microstep drive, the on-board high performance DSP (Digital Signal Processor) performs vector control and filtering, producing a smooth rotational control with minimum ripples.

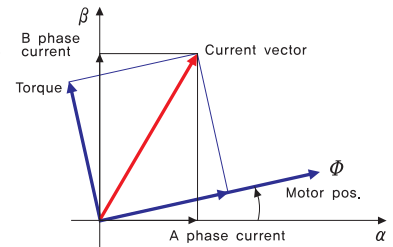

9 Fast Response

Similar to conventional stepping motors, Ezi-SERVO[®] instantly synchronizes with command pulses providing fast positional response. Ezi-SERVO[®] is the optimum choice when zero-speed stability and rapid motions within a short distance are required. Traditional servo motor systems have a natural delay between the commanding input signals and the resultant motion because of the constant monitoring of the current position, necessitating in a waiting time until it settles, called settling time.

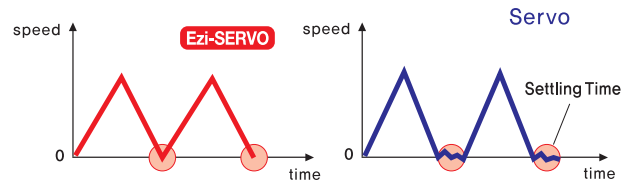

10 High Resolution

The unit of the position command can be divided precisely. (Max. 20,000 pulses/revolution)

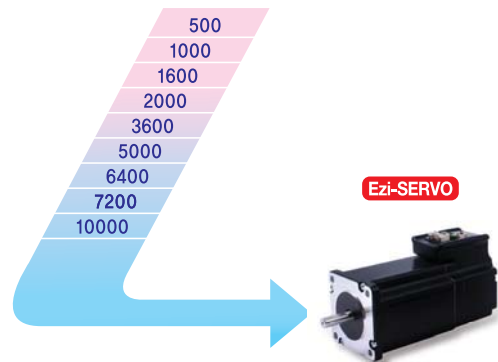

11

High Torque

Compared with common step motors and drives, Ezi-SERVO[®] motion control systems can maintain a high torque state over relatively long period of time. This means that Ezi-SERVO continuously operates without loss of position under 100% of the load. Unlike conventional Microstep drives, Ezi-SERVO[®] exploits continuous high-torque operation during high-speed motion due to its innovative optimum current phase control.

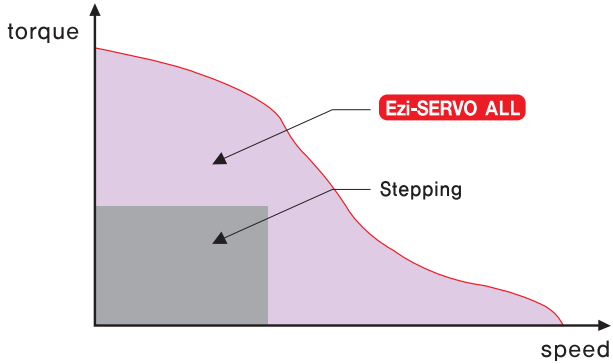

12

High Speed

The Ezi-SERVO[®] functions well at high speed without the loss of Synchronism or positioning error. Ezi-SERVO[®] s ability of continuous monitoring of current position enables the stepping motor to generate high-torque, even under a 100% load condition.

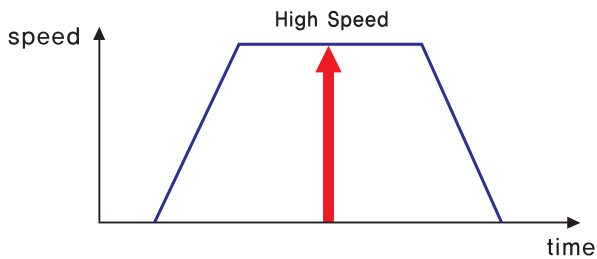

● Features of Motion Controller

1. Loop Count

This function allows positioning repeatedly according to the Loop Count Number.

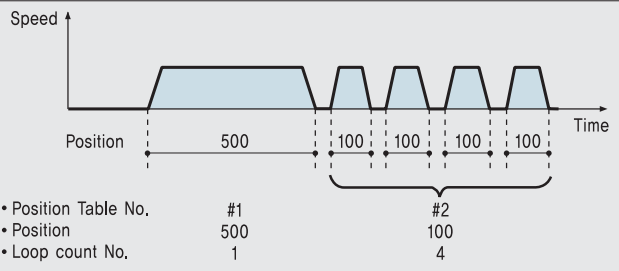

2. Acceleration/Deceleration

For quick acceleration and gradual deceleration, you can set each acceleration and deceleration time separately.

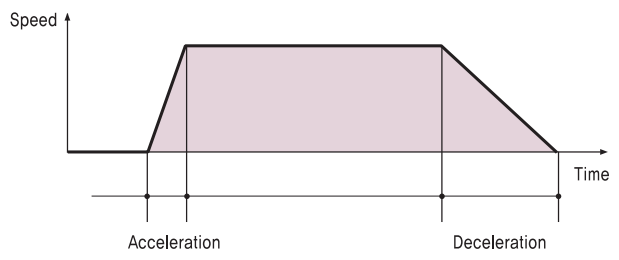

3. Pause

You can pause the motion upon the input of an external signal. When Pause signal change to OFF, the motor will restart to original target position.

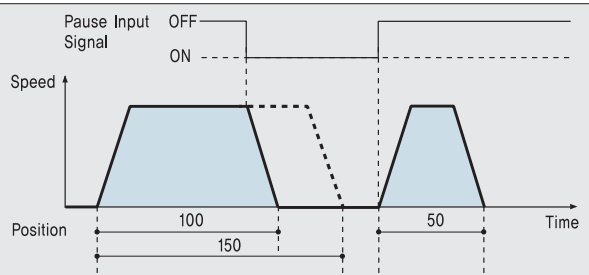

4. Alarm

The number of 7-Segment flashing time indicates which Alarm has occurred.

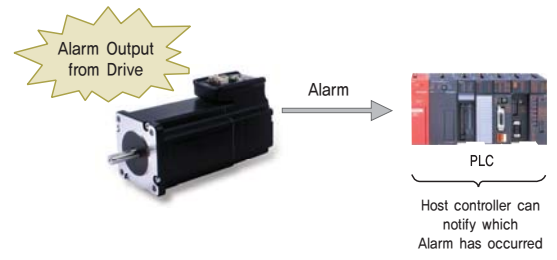

5. Teaching

Teaching signal is used to memorize current Position data into the selected Position Table item.

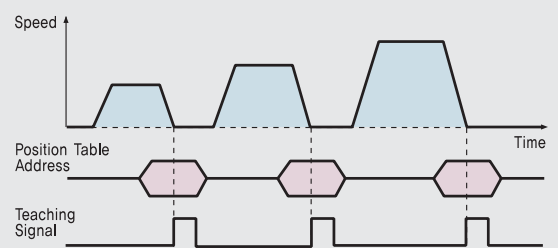

6. Jump

Within one Position Table, you can select various Position Table numbers that you want to jump. With three external input signal during movement, the next jump Position Table number can be select.

◆ Position Table #14

Position	---	Next	---	Input 1	Input 2	Input 3	---
10000		100		115	116	117	

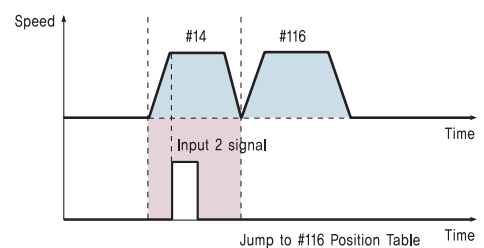
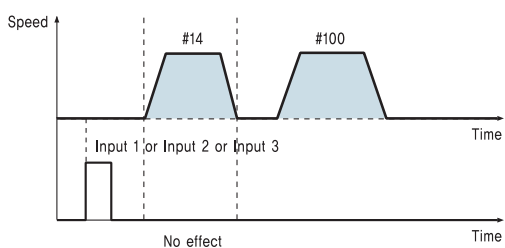

● Part Numbering

Ezi-SERVO-ALL-42S-A-□

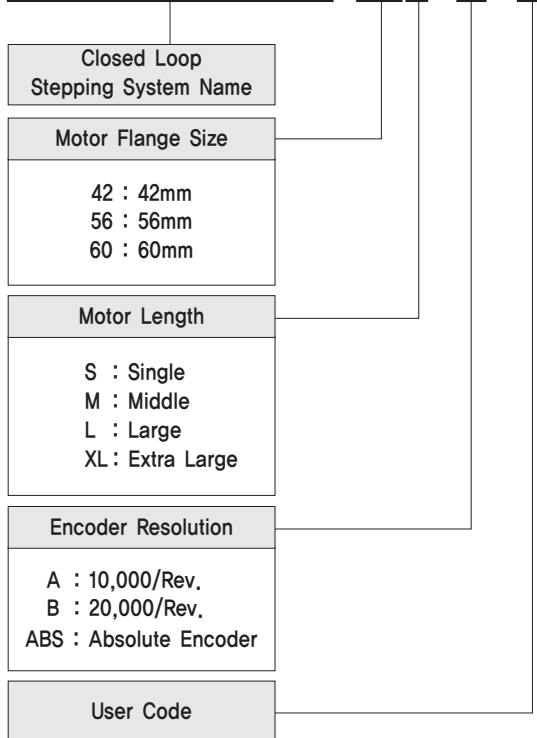

● Combination list of Ezi-SERVO ALL

Part Number
Ezi-SERVO-ALL-42S-A
Ezi-SERVO-ALL-42S-B
Ezi-SERVO-ALL-42M-A
Ezi-SERVO-ALL-42M-B
Ezi-SERVO-ALL-42L-A
Ezi-SERVO-ALL-42L-B
Ezi-SERVO-ALL-42XL-A
Ezi-SERVO-ALL-42XL-B
Ezi-SERVO-ALL-56S-A
Ezi-SERVO-ALL-56S-B
Ezi-SERVO-ALL-56M-A
Ezi-SERVO-ALL-56M-B
Ezi-SERVO-ALL-56L-A
Ezi-SERVO-ALL-56L-B
Ezi-SERVO-ALL-60S-A
Ezi-SERVO-ALL-60S-B
Ezi-SERVO-ALL-60M-A
Ezi-SERVO-ALL-60M-B
Ezi-SERVO-ALL-60L-A
Ezi-SERVO-ALL-60L-B
Ezi-SERVO-ALL-60L-ABS

● Advantages over Open-loop Control Stepping Drive

1. Reliable positioning without loss of synchronism,
2. Holding stable position and automatically recovering to the original position even after experiencing positioning error due to a external force, such as mechanical vibration,
3. Ezi-SERVO² ALL covers 100% full range of the rated torque, contrary to a conventional open-loop stepping driver that can use only up to 50% of the rated torque by considering loss of synchronism,
4. Capability to operate at high speed owing to a load-dependant current control, whereas open-loop driver use a constant current control at all speed range without considering load variations,

● Advantages over Servo motor controller

1. No gain tuning (Automatic adjustment of gain in response to a load change.)
2. Maintains the stable holding position without fluctuation after completing positioning,
3. Fast positioning due to the independent control by on-board DSP,
4. Continuous operation during rapid short-stroke movement due to instantaneous positioning,

● Specifications

Input Voltage		24VDC \pm 10%
Control Method		Closed loop control with 32bit DSP
Multi Axes Drive		Maximum 16 axes through Daisy-Chain
Position Table		64 motion command steps (Continuous, Wait, Loop, Jump and External start etc.)
Current Consumption		Max 500mA (Except motor current)
Operating Condition	Ambient Temperature	In Use : 0~55°C In Storage : -20~70°C
	Humidity	In Use : 35~85% (Non-condensing) In Storage : 10~90% (Non-condensing)
	Vib. Resist.	0,5G
Function	Rotation Speed	0~3000rpm
	Resolution(P/R)	10000/Rev. Encoder model : 500, 1000, 1600, 2000, 3600, 5000, 6400, 7200, 10000 20000/Rev. Encoder model : 500, 1000, 1600, 2000, 3600, 5000, 6400, 7200, 10000, 20000
	Protection Functions	Over Current Error, Over Speed Error, Step Out Error, Over Load Error, Over Temperature Error, Over Regenerated Voltage Error, Motor Connect Error, Encoder Connect Error, Low Input Voltage Error, Inposition Error, System Error, ROM Error, High Input Voltage Error
	In-Position Selection	0~15 (Selectable by parameter)
	Position Gain Selection	0~15 (Selectable by parameter)
	Rotational Direction	CW / CCW (Selectable by parameter)
I/O Signal	Input Signal	3 dedicated input (LIMIT+, LIMIT-, ORIGIN), 7 programmable input (photocoupler)
	Output Signal	1 dedicated output (Compare Out), 1 programmable output (photocoupler)
I/O Signal	Input Signal	3 dedicated input (LIMIT+, LIMIT-, ORIGIN), 7 programmable input (photocoupler) ^{*1}
	Output Signal	1 dedicated output (Compare Out), 3 programmable output (photocoupler) ^{*1}
I/O Signal	Input Signal	3 dedicated input (LIMIT+, LIMIT-, ORIGIN), 6 programmable input (photocoupler) ^{*2}
	Output Signal	1 dedicated output (Compare Out), 6 programmable output (photocoupler) ^{*2}
Communication Interface		The RS-485 serial communication with PC Transmission speed : 9,6k~921,600[bps]
Position Control		Incremental mode/Absolute mode Data Range : -134,217,727 to +134,217,727[pulse], Operating speed : Max. 500[kpps]
Return to Origin		Origin sensor, Z phase, \pm Limit sensor
GUI		User Interface Program within Windows
Software		Motion Library (DLL) for windows 2000/XP

*1 Only for Ezi-SERVO-ALL-60 Series

*2 Only for Ezi-SERVO-ALL-60L-ABS Series

● Motor Specification

M O D E L		UNIT	Ezi-SERVO-ALL 42S Series	Ezi-SERVO-ALL 42M Series	Ezi-SERVO-ALL 42L Series	Ezi-SERVO-ALL 42XL Series
DRIVE METHOD		----	BI-POLAR	BI-POLAR	BI-POLAR	BI-POLAR
NUMBER OF PHASES		----	2	2	2	2
VOLTAGE		VDC	3.36	4.32	4.56	7.2
CURRENT per PHASE		A	1.2	1.2	1.2	1.2
RESISTANCE per PHASE		Ohm	2.8	3.6	3.8	6.0
INDUCTANCE per PHASE		mH	2.5	7.2	8.0	15.6
HOLDING TORQUE		N · m	0.32	0.44	0.5	0.65
ROTOR INERTIA		g · cm ²	35	54	77	114
WEIGHTS		g	220	280	350	500
LENGTH (L)		mm	33	39	47	59
ALLOWABLE OVERHUNG LOAD (DISTANCE FROM END OF SHAFT)	3mm	N	22	22	22	22
	8mm		26	26	26	26
	13mm		33	33	33	33
	18mm		46	46	46	46
ALLOWABLE THRUST LOAD		N	Lower than motor weight			
INSULATION RESISTANCE		MOhm	100min, (at 500VDC)			
INSULATION CLASS		----	CLASS B (130°C)			
OPERATING TEMPERATURE		°C	0 to 55			

● Motor Dimension [mm] and Torque Characteristics

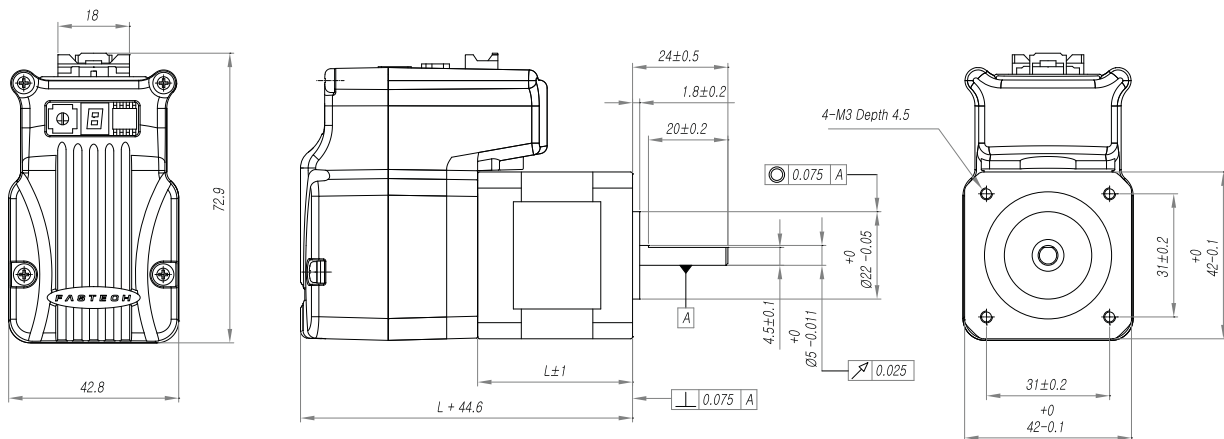

FASTECH Ezi-SERVO ALL

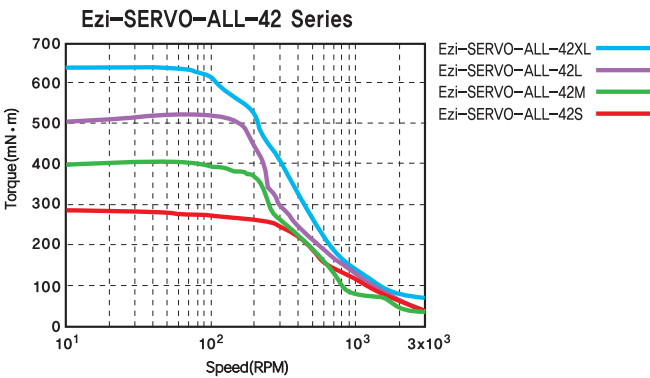

※ Measured Condition

Motor Voltage = 24VDC

Motor Current = Rated Current(Refer to Motor Specification)

Drive = Ezi-SERVO ALL

● Motor Specification

M O D E L		UNIT	Ezi-SERVO-ALL 56S Series	Ezi-SERVO-ALL 56M Series	Ezi-SERVO-ALL 56L Series
DRIVE METHOD		----	BI-POLAR	BI-POLAR	BI-POLAR
NUMBER OF PHASES		----	2	2	2
VOLTAGE		VDC	1,56	1,62	2,7
CURRENT per PHASE		A	3	3	3
RESISTANCE per PHASE		Ohm	0,52	0,54	0,9
INDUCTANCE per PHASE		mH	1,0	2,0	3,8
HOLDING TORQUE		N · m	0,64	1,0	1,5
ROTOR INERTIA		g · cm ²	120	200	480
WEIGHTS		g	500	700	1150
LENGTH (L)		mm	46	54	80
ALLOWABLE OVERHUNG LOAD (DISTANCE FROM END OF SHAFT)	3mm	N	52	52	52
	8mm		65	65	65
	13mm		85	85	85
	18mm		123	123	123
ALLOWABLE THRUST LOAD		N	Lower than motor weight		
INSULATION RESISTANCE		MOhm	100min. (at 500VDC)		
INSULATION CLASS		----	CLASS B (130°C)		
OPERATING TEMPERATURE		°C	0 to 55		

● Motor Dimension [mm] and Torque Characteristics

FASTECH Ezi-SERVO ALL

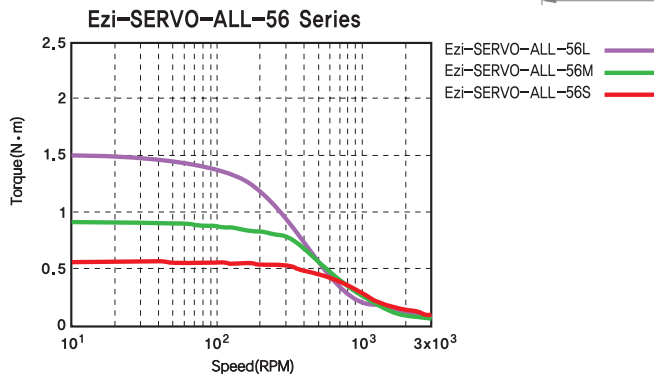
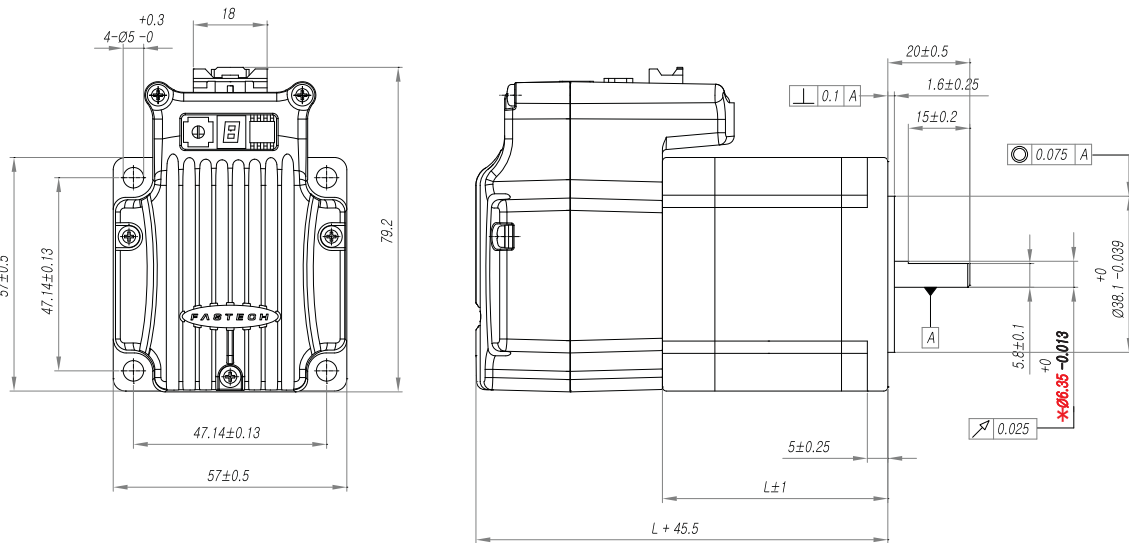

※ Measured Condition

Motor Voltage = 24VDC
 Motor Current = Rated Current(Refer to Motor Specification)
 Drive = Ezi-SERVO ALL

* There are 2 kinds size of front shaft diameter for Ezi-SERVO-ALL-56 series as $\Phi 6.35$ and $\Phi 8.0$.

IP65 Product 60

● Motor Specification

M O D E L		UNIT	Ezi-SERVO-ALL 60S Series	Ezi-SERVO-ALL 60M Series	Ezi-SERVO-ALL 60L Series
DRIVE METHOD		----	BI-POLAR	BI-POLAR	BI-POLAR
NUMBER OF PHASES		----	2	2	2
VOLTAGE		VDC	1.52	1.56	2.6
CURRENT per PHASE		A	4	4	4
RESISTANCE per PHASE		Ohm	0.38	0.39	0.65
INDUCTANCE per PHASE		mH	0.64	1.2	2.4
HOLDING TORQUE		N · m	0.88	1.28	2.4
ROTOR INERTIA		g · cm ²	140	320	800
WEIGHTS		g	600	900	1600
LENGTH (L)		mm	46	56	90
ALLOWABLE OVERHUNG LOAD (DISTANCE FROM END OF SHAFT)	3mm	N	70	70	70
	8mm		87	87	87
	13mm		114	114	114
	18mm		165	165	165
ALLOWABLE THRUST LOAD		N	Lower than motor weight		
INSULATION RESISTANCE		MOhm	100min, (at 500VDC)		
INSULATION CLASS		----	CLASS B (130°C)		
OPERATING TEMPERATURE		°C	0 to 55		

* Ezi-SERVO-ALL-60mm series only supply IP65 Type of products.

● Motor Dimension [mm] and Torque Characteristics

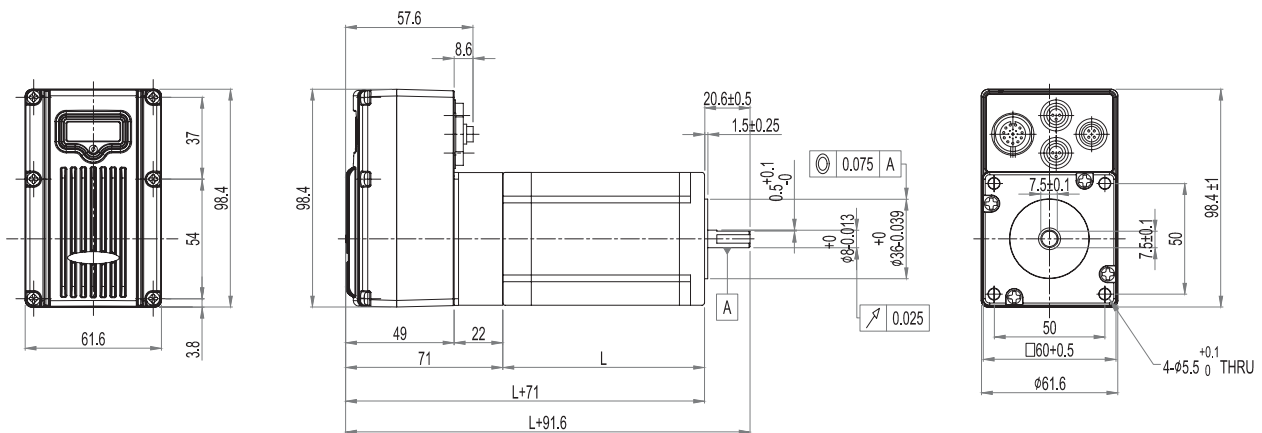

FASTECH Ezi-SERVO ALL

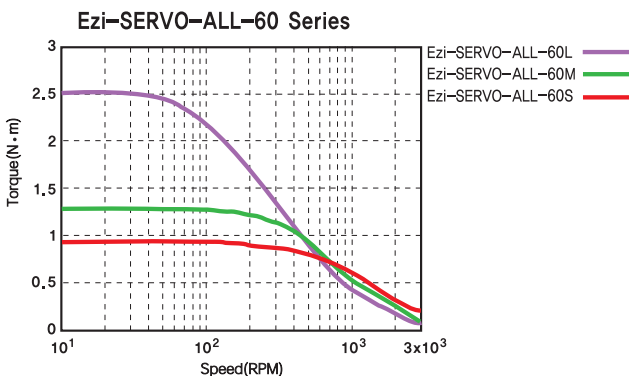

※ Measured Condition

Motor Voltage = 24VDC

Motor Current = Rated Current (Refer to Motor Specification)

Drive = Ezi-SERVO ALL

● Setting and Operating (ALL-42, ALL-56 Series)

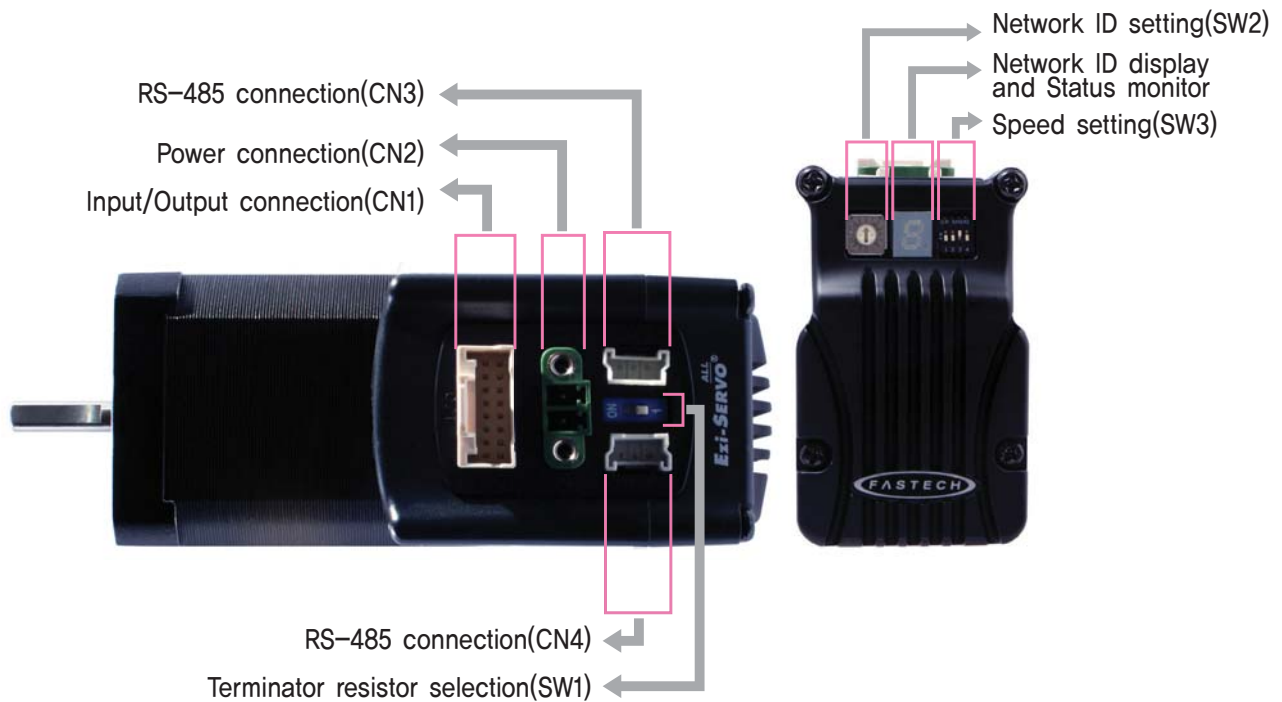

◆ Protection function and 7-Segment flash times

When Alarm occurs, can recognize main reason of alarming thru by 7-Segment flash times which indicates Network ID.

Times	Protection	Conditions
1	Over Current Error	The current through power devices in inverter exceeds the limit value
2	Over Speed Error	Motor speed exceed 3000rpm
3	Step Out Error	Position values is higher than specified value in motor stop status *1
4	Over Load Error	The motor is continuously operated more than 5 second under a load exceeding the max. torque
5	Over Temperature Error	Inside temperature of drive exceeds 85°C
6	Over Regenerated Voltage Error	Back-EMF more than high limit value
7	Motor Connect Error	The power is ON without connection of the motor cable to drive
8	Encoder Connect Error	Cable connection error with Encoder connector in drive
9	Low Input Voltage Error	The power supplied to the motor is less than low limit value
10	Inposition Error	After operation is finished, a position error occurs
11	System Error	Error occurs indrive system
12	ROM Error	Error occurs during tuning execution
14	Input Voltage Error	Power source voltage is out of limited value as 20V~28V
15	Position Overflow Error	Position error value is higher thab 90° in motor stop state *1

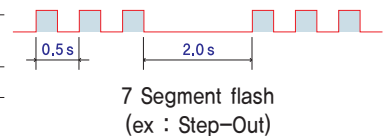

*1 : Default value can be changed by parameter (Refer to Manual)

1. Terminator Resistor Selection(SW1)

Terminator resistor selection switch under RS-485 communication. Please set ON for Terminator Controller of Network.

2. Network ID Selection Switch(SW2)

Position	ID number	Position	ID number
0	0	8	8
1	1	9	9
2	2	A	10
3	3	B	11
4	4	C	12
5	5	D	13
6	6	E	14
7	7	F	15

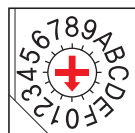

*Maximum 16 axis can be connected in one network.

3. Speed and Terminator Resistor Selection Switch(SW3)

The purpose of this is to setting the communication speed

SW 3.1	SW 3.2	SW 3.3	Baud rate[bps]
OFF	OFF	OFF	9600
ON	OFF	OFF	19200
OFF	ON	OFF	38400
ON	ON	OFF	57600
OFF	OFF	ON	115200*1
ON	OFF	ON	230400
OFF	ON	ON	460800
ON	ON	ON	921600

*Possible to use common PCI Bus type RS-485 communication board for High speed communication. (Please contact with Distributor)

*1 : Default setting value

*2 : SW3,4 is not available to use

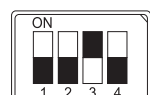

4. Input/Output Signal(CN1)

NO.	Function	I/O
1	24VDC	Input
2	24VDC GND	Input
3	BRAKE+	Output
4	BRAKE-	Output
5	LIMIT+	Input
6	LIMIT-	Input
7	ORIGIN	Input
8	Digital IN1	Input
9	Digital IN2	Input
10	Digital IN3	Input
11	Digital IN4	Input
12	Digital IN5	Input
13	Digital IN6	Input
14	Digital IN7	Input
15	Compare Out	Output
16	Digital OUT1	Output

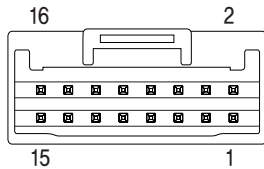

5. Power Connector(CN2)

NO.	Function
1	Input Voltage : 24VDC \pm 10%
2	Input Voltage : GND

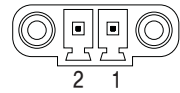

6. RS-485 Communication Connector(CN3, CN4)

There is a converter for connecting PC.

NO.	Function
1	+DATA
2	-DATA
3	GND

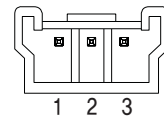

◆ Connector for Cabling

These connectors are serviced together with Ezi-SERVO ALL except when purchasing option cables

CN1 : I/O Connection Connector

Item	Specification	Maker
Housing	501646-1600	MOLEX
Terminal	501648-1000 (AWG 26~28)	MOLEX

CN2 : Power Connection Connector

Item	Specification	Maker
Terminal Block	AKZ1550/2F-3,81	PTR

CN3, CN4 : RS-485 Communication Connector

Item	Specification	Maker
Housing	33507-0300	MOLEX
Terminal	50212-8100	MOLEX

● Setting and Operating (ALL-60 Series)

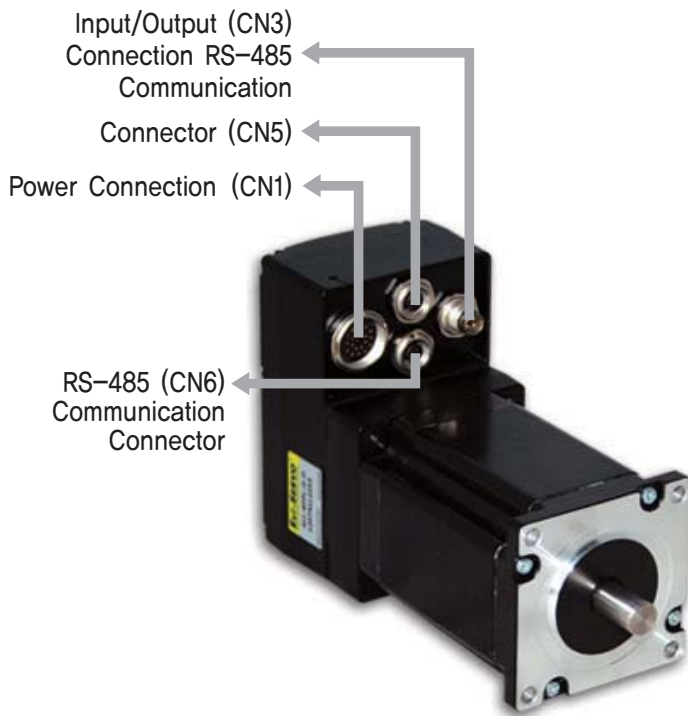

◆ Ezi-SERVO-ALL-60L-ABS

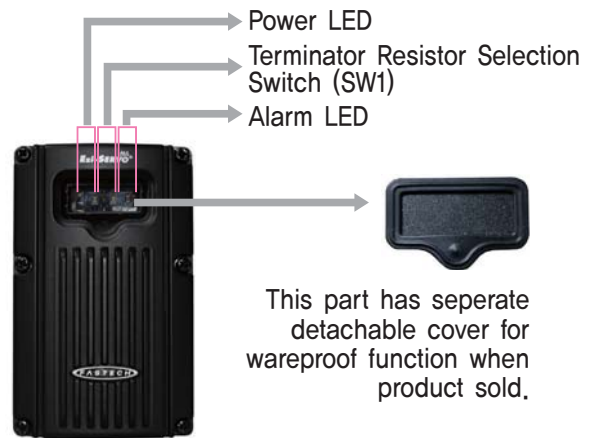

◆ Ezi-SERVO-ALL-60 Series

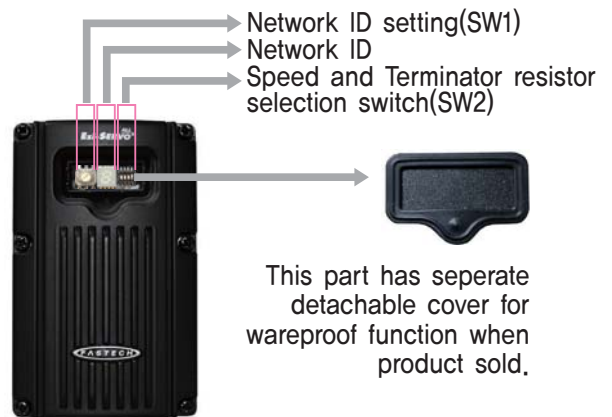

◆ Protection function and LED flash times

When Alarm occurs, can recognize main reason of alarming thru by LED flash times.

Times	Protection	Conditions
1	Over Current Error	The current through power devices in inverter exceeds the limit value
2	Over Speed Error	Motor speed exceed 3,000rpm
3	Position Tracking Error	Position error value is higher than 90° in motor run state*1
4	Over Load Error	The motor is continuously operated more than 5 second under a load exceeding the max. torque
5	Over Temperature Error	Inside temperature of drive exceeds 85°C
6	Over Regenerated Voltage Error	Back-EMF more than 50V
7	Motor Connect Error	The power is ON without connection of the motor cable to drive
8	Encoder Connect Error	Cable connection error with Encoder connector in drive
9	Motor Voltage Error	Motor voltage is less than 20V
10	In-Position Error	After operation is finished, a position error occurs
11	System Error	Error occurs in drive system
12	ROM Error	Error occurs in parameter storage device(ROM)
14	Input Voltage Error	Power source voltage is out of limited value
15	Position Overflow Error	Position error value is higher than 90° in motor stop state*1

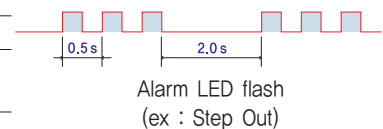

*1 : Default value can be changed by
Parameter (Refer to Manual)

1. Terminator Resistor Selection Switch(SW1)

Terminator resistor selection switch under RS-485 communication, please set ON for Terminator Controller of Network.



2. Network ID Selection Switch(SW1)

Position	ID number	Position	ID number
0	0	8	8
1	1	9	9
2	2	A	10
3	3	B	11
4	4	C	12
5	5	D	13
6	6	E	14
7	7	F	15



※Maximum 16 axis can be connected in one network.

3. Speed and Terminator Resistor Selection Switch(SW2)

The purpose of this is to setting the communication speed and connect a terminator resistor if drive is installed at the end of network.

SW 2,1 used for connecting the terminator resistor.
SW 2,2~SW 2,4 used for setting speed as follows.

SW 2,1	SW 2,2	SW 2,3	SW 2,4	Baud rate[bps]
–	OFF	OFF	OFF	9,600
–	ON	OFF	OFF	19,200
–	OFF	ON	OFF	38,400
–	ON	ON	OFF	57,600
–	OFF	OFF	ON	115,200*1
–	ON	OFF	ON	230,400
–	OFF	ON	ON	460,800
–	ON	ON	ON	921,600

*1 : Default setting value

If SW2,1 is OFF, terminator resistor is disconnected.
If SW2,2 is ON, terminator resistor is connected.

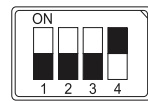

4. Input/Output Connection Connector(CN1)

No.	Function*1	Function*2	I/O*1	I/O*2
A	24VDC	24VDC	Input	Input
B	24VDC GND	24VDC GND	Input	Input
C	LIMIT+	LIMIT+	Input	Input
D	LIMIT-	LIMIT-	Input	Input
E	ORIGIN	ORIGIN	Input	Input
F	Digital IN1	Digital IN1	Input	Input
G	Digital IN2	Digital IN2	Input	Input
H	Digital IN3	Digital IN3	Input	Input
I	Digital IN4	Digital IN4	Input	Input
K	Digital IN5	Digital IN5	Input	Input
L	Digital IN6	Digital IN6	Input	Input
M	Digital IN7	Digital OUT1	Input	Output
N	Compare Out	Digital OUT2	Output	Output
O	Digital OUT1	Digital OUT3	Output	Output
P	Digital OUT2	Digital OUT4	Output	Output
R	Digital OUT3	Digital OUT5	Output	Output
S	N · C	Digital OUT6	Output	Output
T	BRAKE+	BRAKE+	Output	Output
U	BRAKE-	BRAKE-	Output	Output

*1 Ezi-SERVO-ALL-60 Series

*2 Ezi-SERVO-ALL-60L-ABS Series

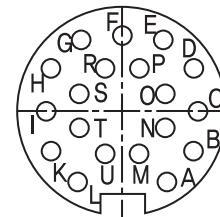

5. Power Connection Connector(CN3)

No.	Function
1	Input Voltage : 24VDC ± 10%
2	Input Voltage : 24VDC ± 10%
3	Input Voltage : GND
4	Input Voltage : GND

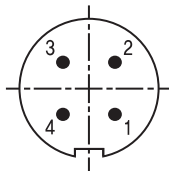

6. RS-485 Communication Connector(CN5, CN6)

No.	Function
1	+DATA
2	-DATA
3	GND

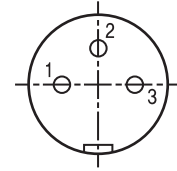

◆ Connector for Cabling

These connectors are serviced together with Ezi-SERVO ALL except when purchasing option cables.

CN1 : Input/Output Connector

Item	Specification	Maker
Connector	99-5461-40-19	Binder

CN5, CN6 : RS-485 Communication Connector

Item	Specification	Maker
Connector	99-0405-00-03	Binder

CN3 : Power Connection Connector

Item	Specification	Maker
Connector	99-0410-00-04	Binder

● System Configuration (ALL-42, ALL-56 Series)

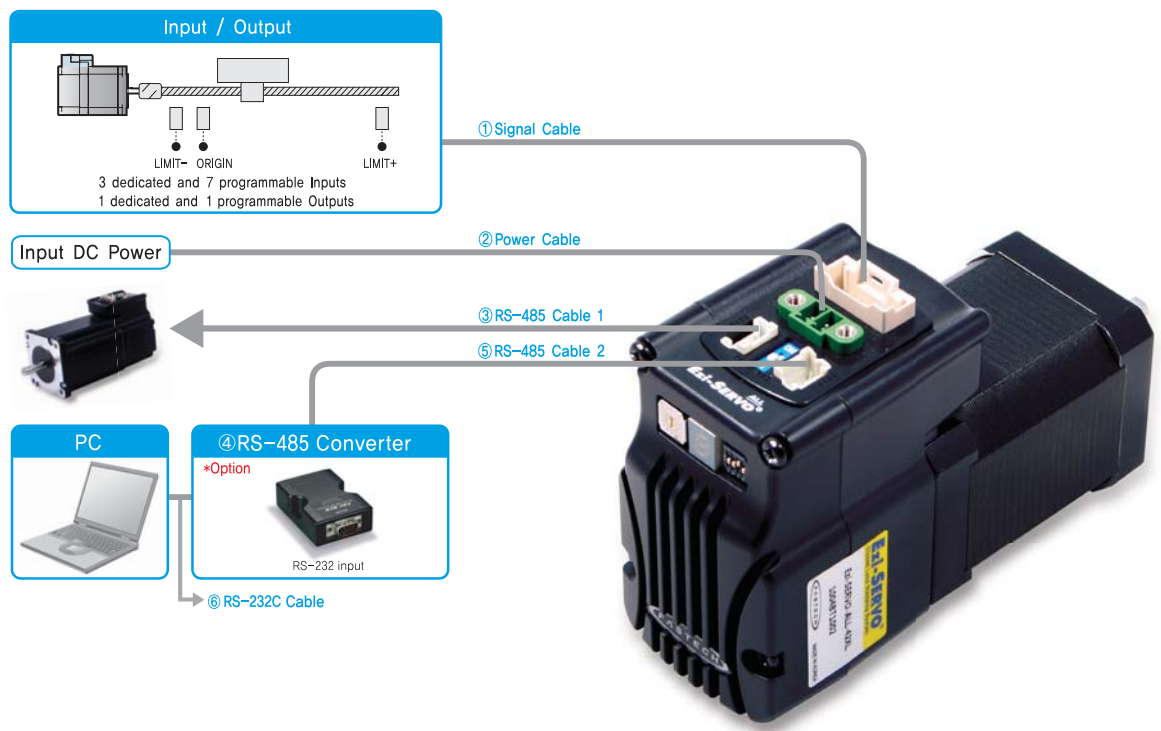

Type	Signal Cable	Power Cable	RS-485 Cable
Standard Length	-	-	-
Max. Length	20m	2m	30m

1. Cable Option (Accessories)

①Signal Cable

Available to connect between Control System and Ezi-SERVO ALL Drive.

Item	Length[m]	Remark
CSVA-S-□□□F	□□□	Normal Cable
CSVA-S-□□□M	□□□	Robot Cable

□ is for Cable Length. The unit is 1m and Max. 20m length.

②Power Cable

Available to connect between Power and Ezi-SERVO ALL Drive.

Item	Length[m]	Remark
CSVA-P-□□□F	□□□	Normal Cable
CSVA-P-□□□M	□□□	Robot Cable

□ is for Cable Length. The unit is 1m and Max. 2m length.

③RS-485 Cable 1

Item	Length[m]	Remark
CGNB-R-0R6F	0,6	Normal Cable
CGNB-R-001F	1	
CGNB-R-1R5F	1,5	
CGNB-R-002F	2	
CGNB-R-003F	3	
CGNB-R-005F	5	

*Common cable to connect Ezi-SERVO ALL, Ezi-STEP ALL, Ezi-MotionLink and Ezi-SERVO MINI Plus-R thru by Network.

2. Option (Accessories)

④FAS-RCR (RS-232C to RS-485 Converter)

Item	Specification
Comm. Speed	Max. 115,2Kbps
Comm. Distance	RS-232C : Max. 15m RS-485 : Max. 1,2km
Connector Type	RS-232C : DB9 Female RS-485 : RJ-45
Operating System	Windows 98/2000/XP/Vista
Dimension	50X75X23mm
Weight	38g
Power	Powered from PC (Usable for external DC5~24V)

⑤RS-485 Cable 2

(FAS-RCR to Ezi-SERVO ALL, FAS-RCR to Ezi-STEP ALL, FAS-RCR to Ezi-SERVO MINI Plus-R, FAS-RCR to Ezi-MotionLink)

Item	Length[m]	Remark
CGNA-R-0R6F	0,6	Normal Cable
CGNA-R-001F	1	
CGNA-R-1R5F	1,5	
CGNA-R-002F	2	
CGNA-R-003F	3	
CGNA-R-005F	5	

⑥RS-232C Cable

Item	Length[m]	Remark
CGNR-C-002F	2	Normal Cable
CGNR-C-003F	3	
CGNR-C-005F	5	

● System Configuration (ALL-60 Series)

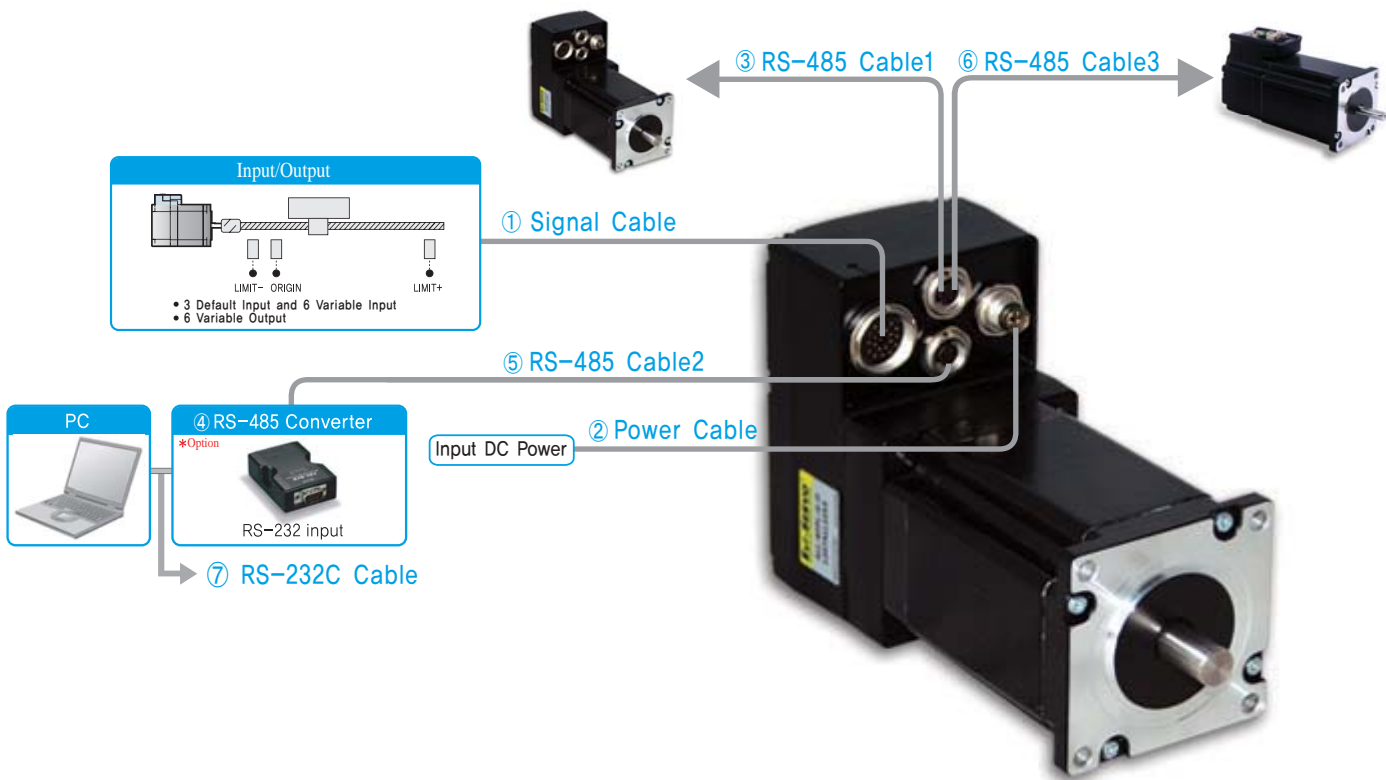

Type	Signal Cable	Power Cable	RS-485 Cable
Standard Length	-	-	-
Max. Length	20m	2m	30m

FASTECH EzI-SERVO ALL

1. Cable Option (Accessories)

① Signal Cable

Available to connect between Control System and Ezi-SERVO-ALL-60 Drive.

Item	Length[m]	Remark
CWPA-S-□□□F*1	□□□	Normal Cable
CWPA-S-□□□M*1	□□□	Robot Cable
CAPA-S-□□□F*2	□□□	Normal Cable
CAPA-S-□□□M*2	□□□	Robot Cable

*1 Ezi-SERVO-ALL-60 Series

*2 Ezi-SERVO-ALL-60L-ABS Series

□ is for Cable Length. The unit is 1m and Max. 20m length.

② Power Cable

Available to connect between Power and Ezi-SERVO-ALL-60 Drive.

Item	Length[m]	Remark
CWPA-P-□□□F	□□□	Normal Cable
CWPA-P-□□□M	□□□	Robot Cable

□ is for Cable Length. The unit is 1m and Max. 2m length.

③ RS-485 Cable 1

Item	Length[m]	Remark
CWPA-R-0R6F	0,6	Normal Cable
CWPA-R-001F	1	
CWPA-R-1R5F	1,5	
CWPA-R-002F	2	
CWPA-R-003F	3	
CWPA-R-005F	5	

Item	Length[m]	Remark
CWPA-R-0R6M	0,6	Robot Cable
CWPA-R-001M	1	
CWPA-R-1R5M	1,5	
CWPA-R-002M	2	
CWPA-R-003M	3	
CWPA-R-005M	5	

*Cable to connect Ezi-SERVO-ALL-60 Series by Network.

2. Option (Accessories)

④ FAS-RCR (RS-232C to RS-485 Converter)

Item	Specification
Comm. Speed	Max 115,2Kbps
Comm. Distance	RS-232C : Max 15m RS-485 : Max 1,2km
Connector type	RS-232C : DB9 Female RS-485 : RJ-45
Dimension	50X75X23mm
Weight	38g
Power	RS-232C Power itself (DC5~24V External Power Usage Available)

⑤ RS-485 Cable 2

(FAS-RCR to Ezi-SERVO-ALL-60 Series)

Item	Length[m]	Remark
CWPB-R-0R6F	0,6	Normal Cable
CWPB-R-001F	1	
CWPB-R-1R5F	1,5	
CWPB-R-002F	2	
CWPB-R-003F	3	
CWPB-R-005F	5	

⑥ RS-485 케이블 3

* Ezi-SERVO-ALL-42,56,60 Series, Ezi-STEP-ALL-42,56 Series

* Ezi-SERVO PR MINI Series, Ezi-STEP PR MINI Series

Network로 연결하는 케이블입니다.

Item	Length[m]	Remark
CWPC-R-0R6F	0,6	Normal Cable
CWPC-R-001F	1	
CWPC-R-1R5F	1,5	
CWPC-R-002F	2	
CWPC-R-003F	3	
CWPC-R-005F	5	

Item	Length[m]	Remark
CWPC-R-0R6M	0,6	Robot Cable
CWPC-R-001M	1	
CWPC-R-1R5M	1,5	
CWPC-R-002M	2	
CWPC-R-003M	3	
CWPC-R-005M	5	

⑦ RS-232C Cable

Item	Length[m]	Remark
CGNR-C-002F	2	Normal Cable
CGNR-C-003F	3	
CGNR-C-005F	5	

● External Wiring Diagram (ALL-42, ALL-56 Series)

Ezi-SERVO-ALL-42
Ezi-SERVO-ALL-56

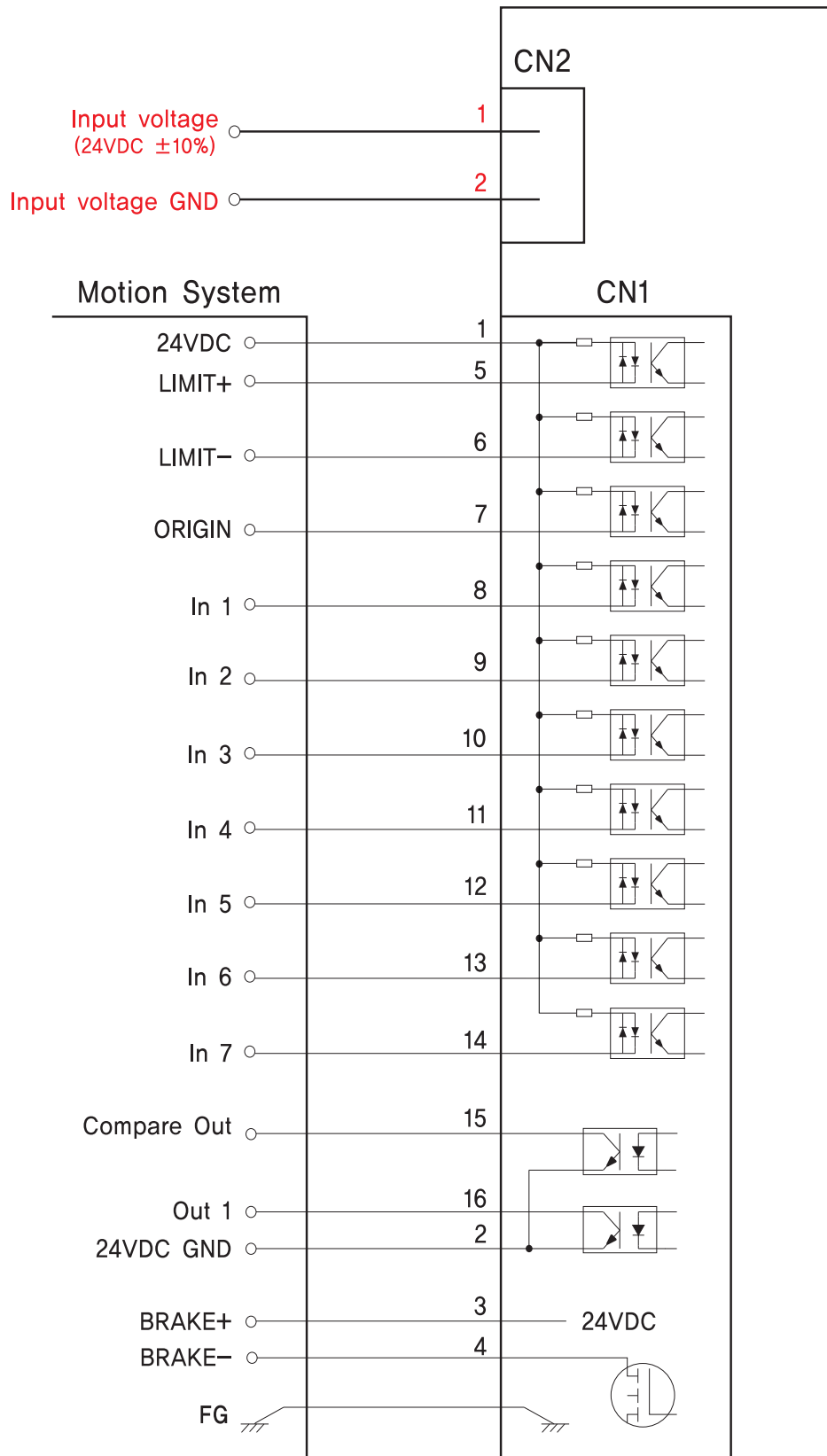

● External Wiring Diagram (ALL-60 Series)

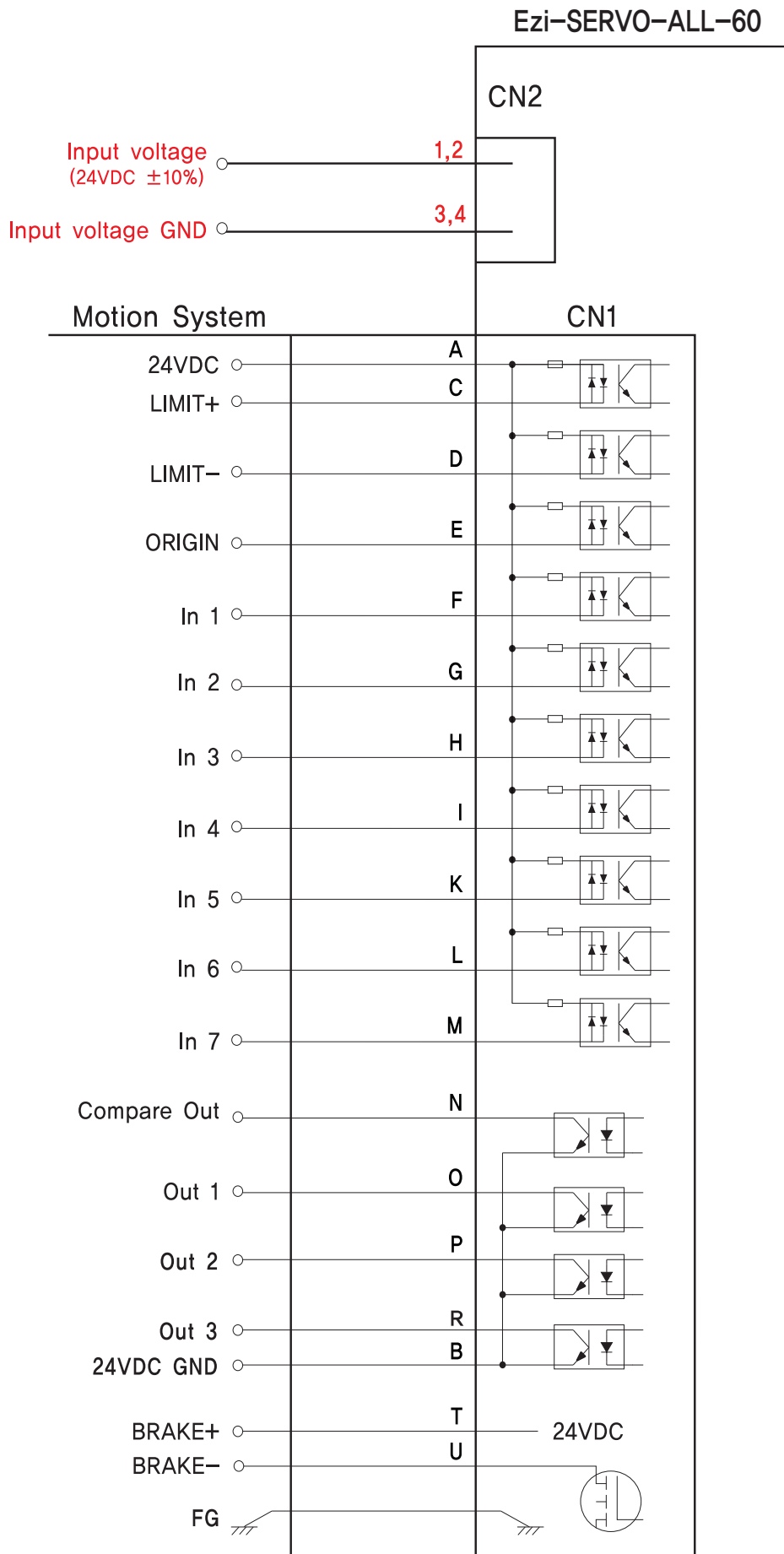

● External Wiring Diagram (ALL-60-ABS)

Ezi-SERVO-ALL-60-ABS

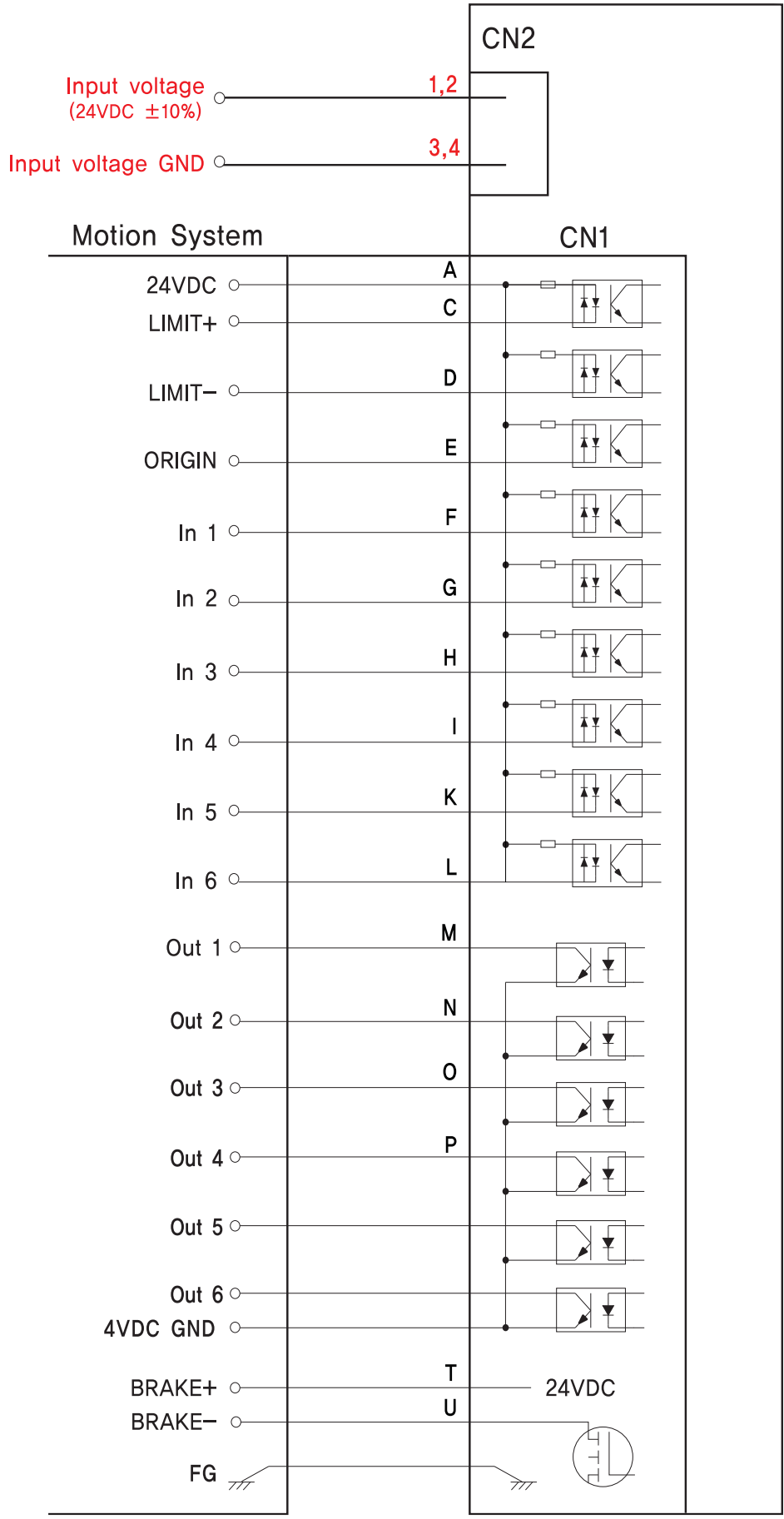

FASTECH Ezi-SERVO ALL

GUI(Graphic User Interface) Screenshot

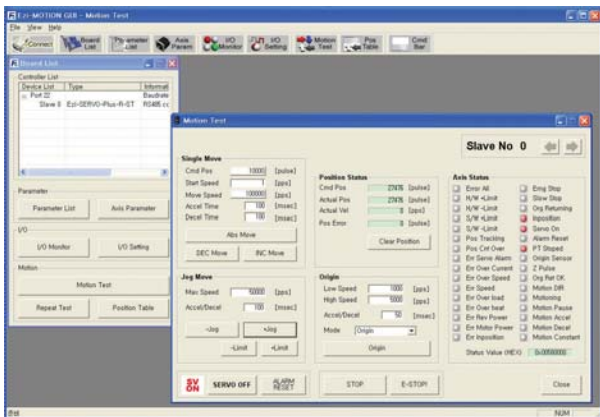

◆Controller Lists and Motion Test

This screen displays the controller list that is connected to the system. You can make a single move, jog, and origin command, and also the motor status is displayed.

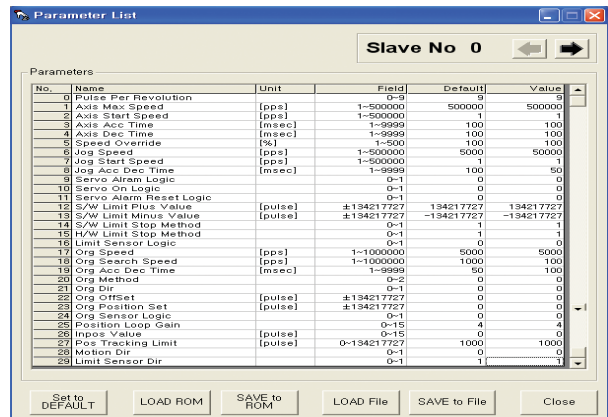

◆Parameter List

All of the parameters are displayed and modified on this screen.

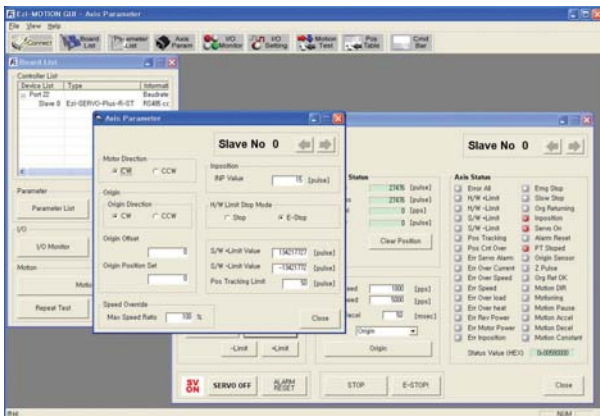

◆Axis Parameter Setup

You can select various parameters that frequently used. (ex : sensor input logic)

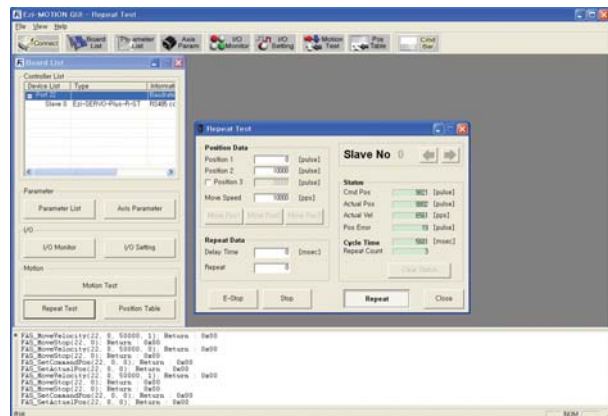

◆Motion Repeat and Monitor Status

Target position, speed, delay time and repeat count are selected for repeat motion test, Motion library(DLL) is also displayed on screen.

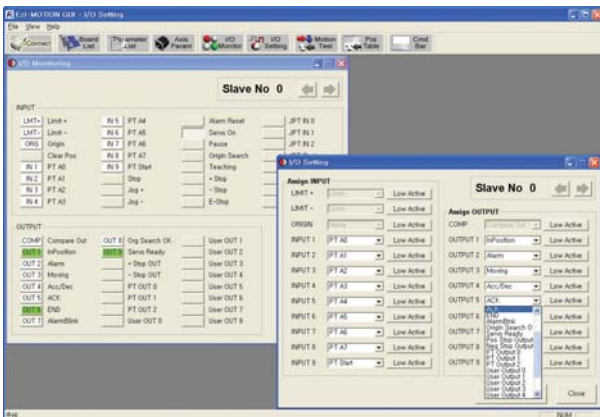

◆I/O Monitoring and Setting

You can select various digital input and output signals of controller.

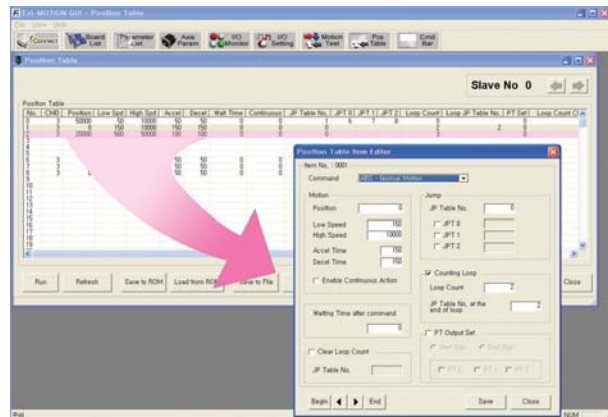

◆Position Table

You can edit the position table and execute it. The position table data can be saved and loaded from Flash ROM and Windows file.



Fast, Accurate, Smooth Motion

FASTECH Co., Ltd.

Rm #1202, Bucheon Technopark 401 Dong, Yakdea-dong,
Wonmi-Gu, Bucheon-si, Gyeonggi-do, Rep. Of Korea (Zip)420-734
TEL : 82-32-234-6300,6301 FAX : 82-32-234-6302
E-mail : fastech@fastech.co.kr Homepage : www.fastech.co.kr

FASTECH AMERICA LLC

811 E Plano Parkway, Suite 110A, Plano, TX 75074 USA
Toll Free: 877-905-4428 972-218-0210
Email: support@fastechamerica.com
website: www.fastechamerica.com